

# The Impact of Internet of Things on Cable Certification

Softing IT Networks

Eric Lie



***Bicsi***



# Agenda

- Short introduction Softing IT Networks
- Brief review on traditional office cabling configurations
- Special cabling requirements for IoT devices
- Normative references
- Differences between traditional horizontal office cabling and IoT cabling
- Testing requirements
- Practical guidelines
- Outlook on future applications
- Summary



# Softing AG Holding – Facts and Figures\*

- Management holding run in accordance with the principles and values of a German medium-sized company
- Headquartered in Haar near Munich, Germany
- Founded 1979
- Publically trade since 2000
- € 80.4 million
- 430 employees (annual average)
- Local presence through own staff in Germany, USA, Italy, France, Austria, Japan, India, China



\* reported for 2016





# Softing AG Business Units

Solutions for  
ECU-diagnostics,  
measurement technology,  
& related communication



Products & technologies for  
industrial production

Test & measurement equipment to verify,  
qualify or certify copper and fiber-optic  
wirings of IT systems

Founded 2003 as legally independent sister  
company of Psiber Data Systems Inc., USA





# Softing T&M Instrumentation for IP Based Systems

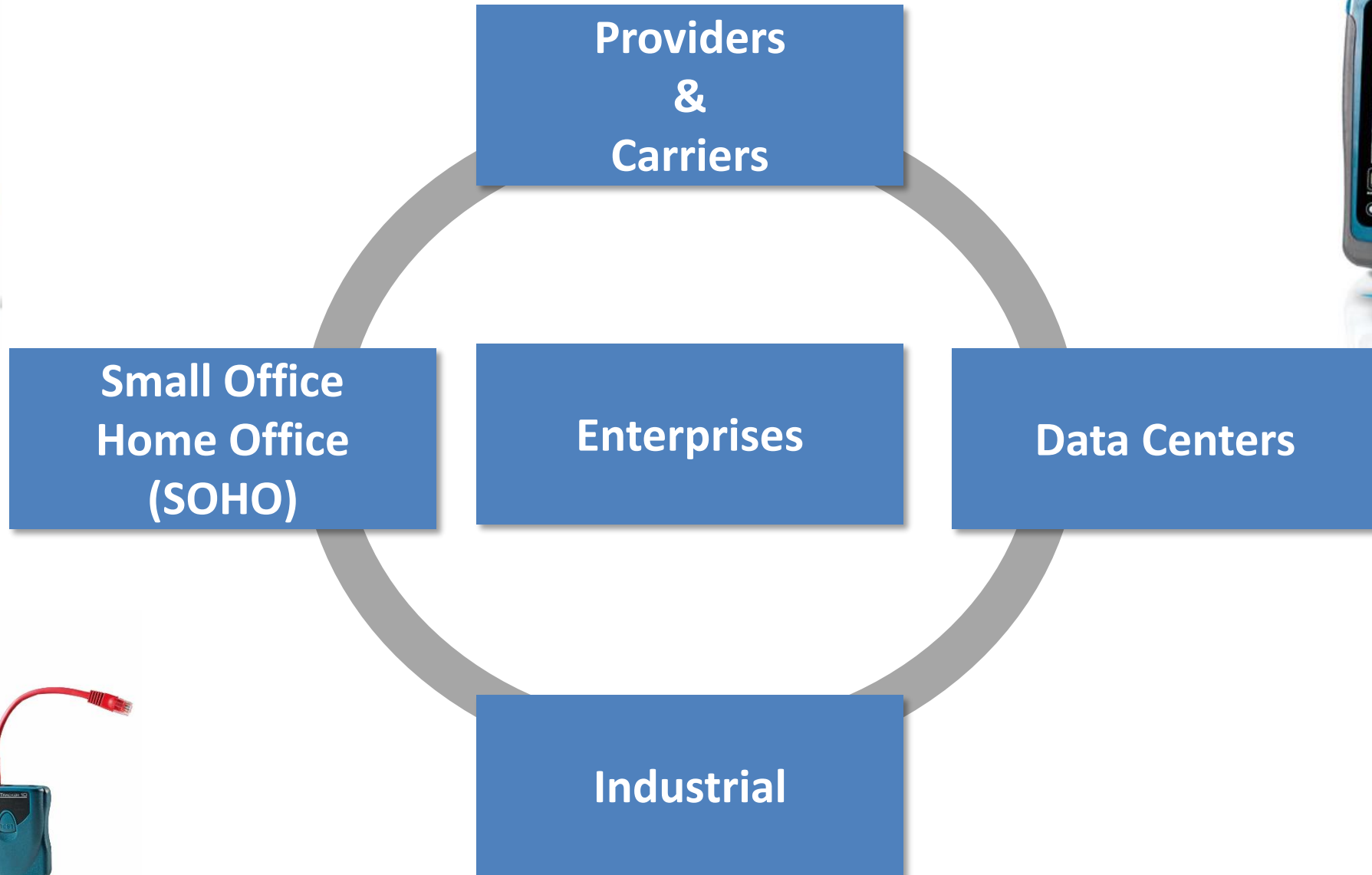





# Brief Review on Traditional Office Cabling Configurations

Test	Implications for Testing
<b>Permanent Link</b> <ul style="list-style-type: none"><li>Permanently fixed installed cabling</li><li>May contain also a consolidation point</li></ul>	<ul style="list-style-type: none"><li>Tester must set reference plane so that first &amp; last connector of link is included in measurement</li><li>Test cords have test plugs</li></ul>
<b>Channel</b> <ul style="list-style-type: none"><li>Permanent Link</li><li>+ all attached patch cords and cross connects</li></ul>	<ul style="list-style-type: none"><li>Tester must include any patch cords</li><li>First and last connectors of cords are <b>EXCLUDED</b></li><li>Test cords have test plugs</li></ul>

Note:  
PL may include a consolidation point

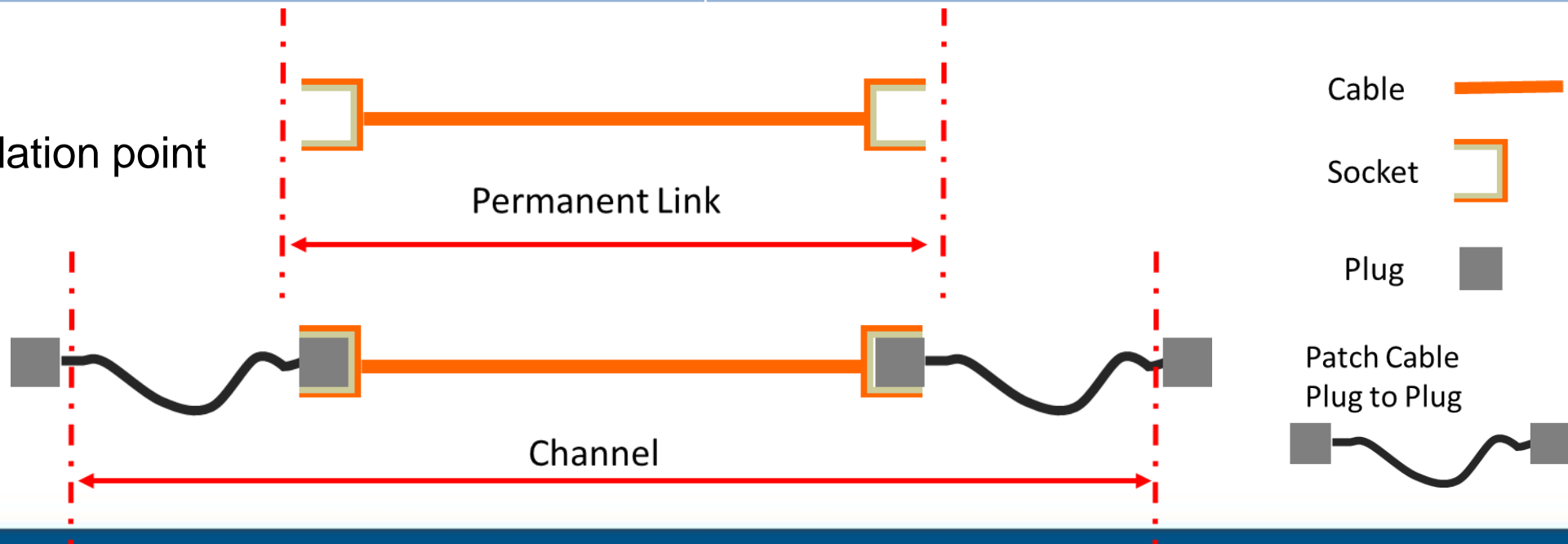



# Brief Review on Traditional Office Cabling Configurations

Measurement starts before permanent link connector

Measurement ends after permanent link connector

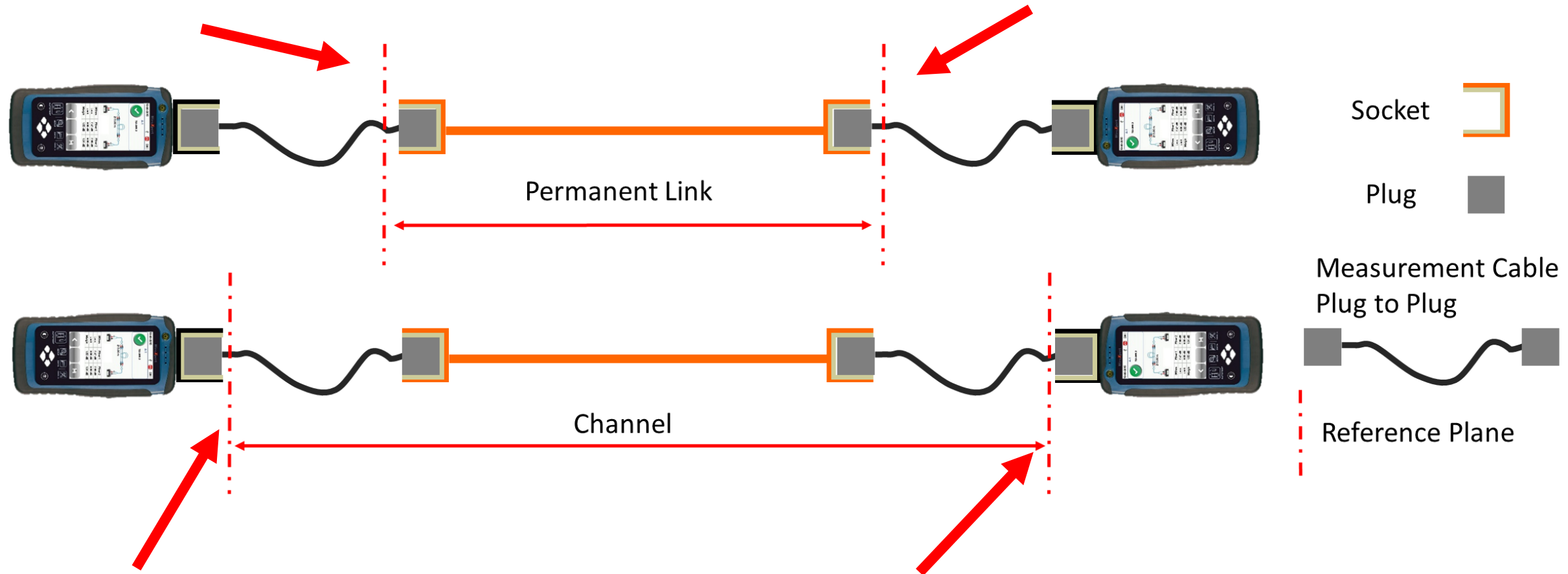

Measurement starts AFTER first connector  
first connector is not included

Measurement ends BEFORE last connector  
last connector is not included



# Special Cabling Requirements for IoT Devices

- Cabling Configurations
    - Classical Channel and Permanent Link often is impractical
    - Devices often need to be connected without additional patch cord
      - Examples:
        - Access points or cameras on walls
        - Sensors
        - Building automation devices
  - Length
    - In future, the classical 100m will not be enough
- => Devices need to be directly connected to each other  
– daisy chain or point to multipoint







# Special Cabling Requirements for IoT Devices

- Connectors
  - „Office“ RJ45 often is not enough
  - Variety of different connectors
    - Ruggedized RJ45 housings  
dustproof, waterproof, oil proof, sturdy
    - M12-D coded
    - M12-X coded
    - M8
    - IX
    - Terminal screws
    - **Future: various 1 pair connectors**



⇒ **Challenge for field tester – need to provide connectivity for all kinds of different systems!**



# Special Cabling Requirements for IoT Devices

- Star Topology vs Daisy-Chain or Point-to-Multipoint

Office Cabling – „Star“ Configuration

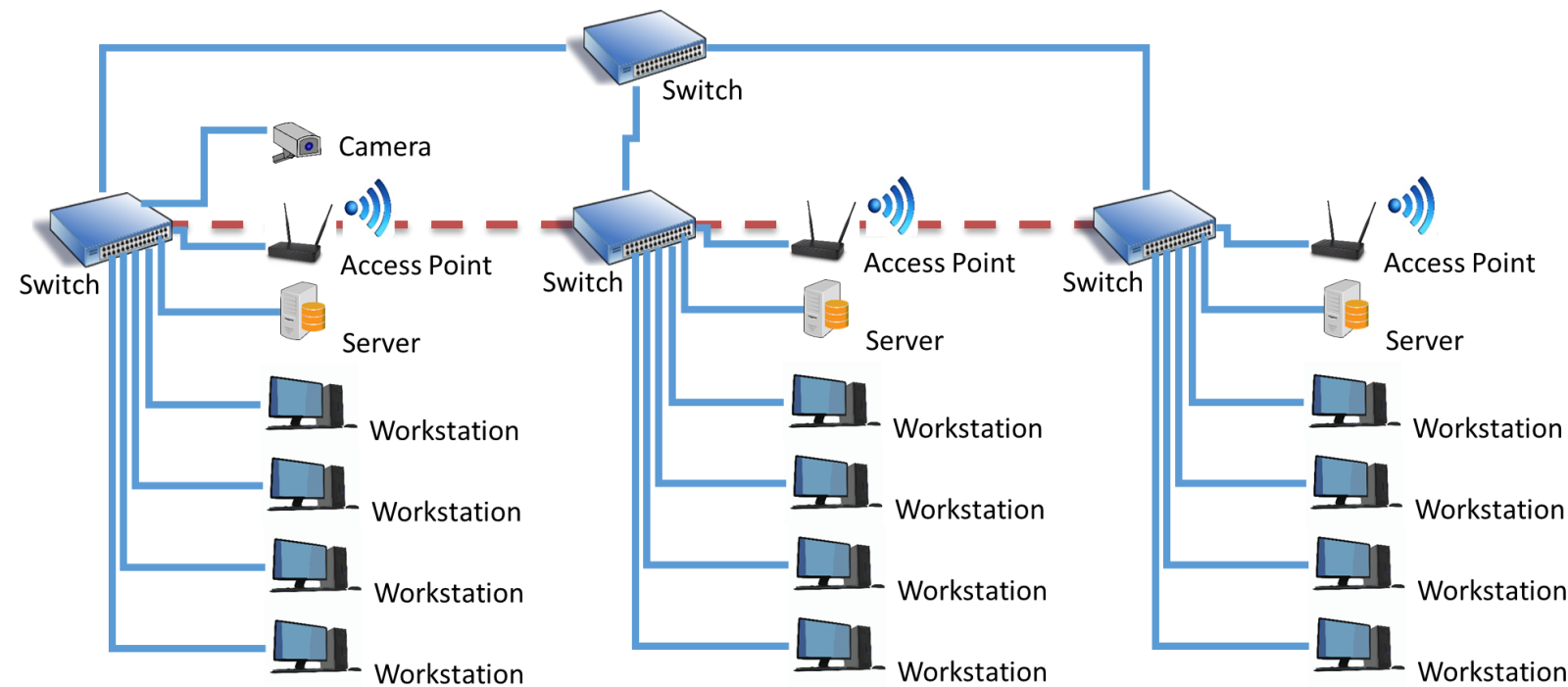

IoT Cabling – Mix of „Star“ and „Daisy Chain“ Configurations

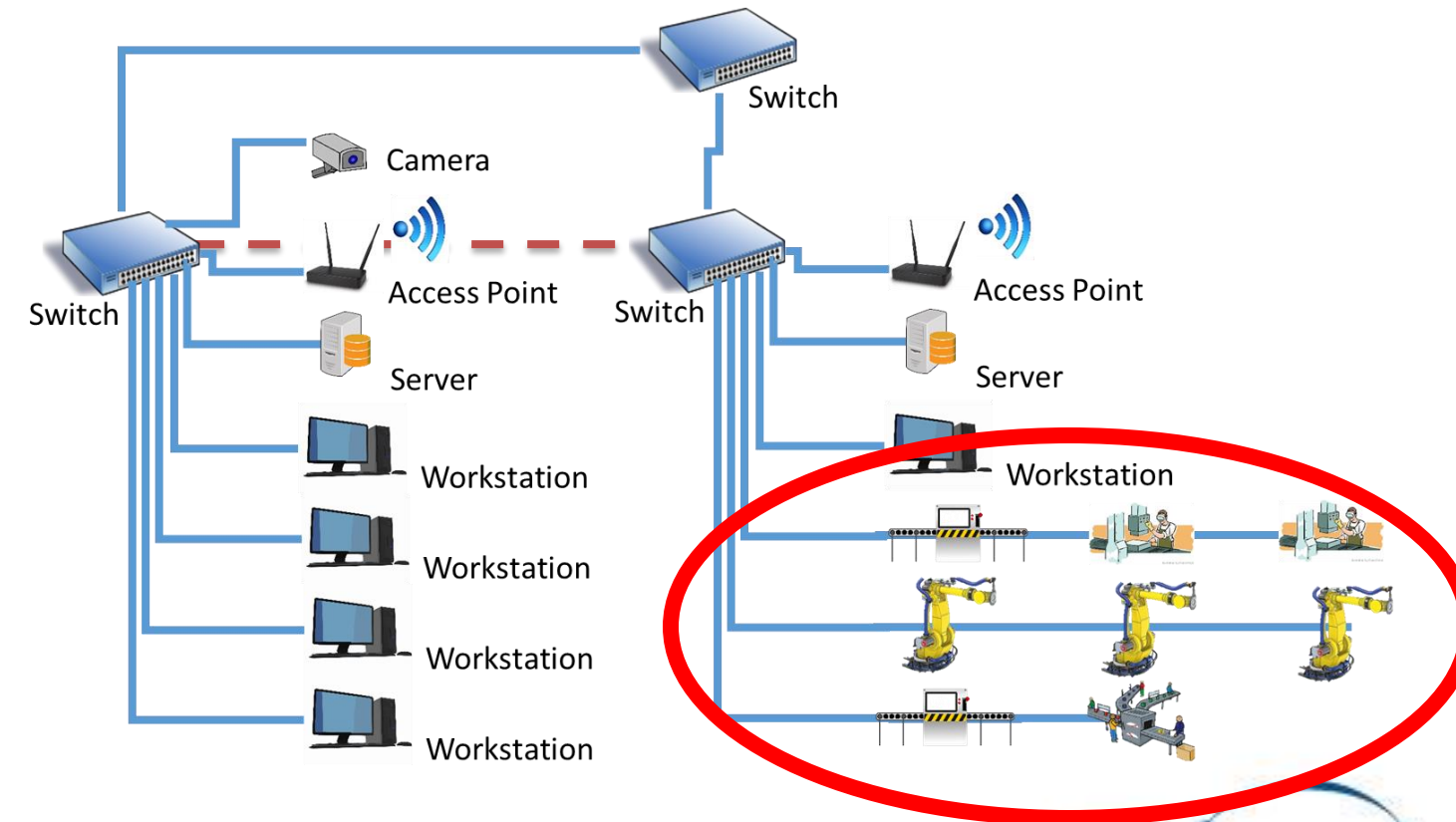

Note: in larger network configurations meshed networks for redundancy purposes can be found



# Special Cabling Requirements for IoT Devices

- New: E2E link configuration - E2E = End-to-End
- Up to 100m on solid wires, ~ 80m on stranded (depends on brand)
- „Looks like“ a permanent link – but note that an E2E has plugs at the ends!
- Purpose: Direct connect equipment without using patch cables
- Plugs at the ends need to be included in test **because they can be terminated in the field**

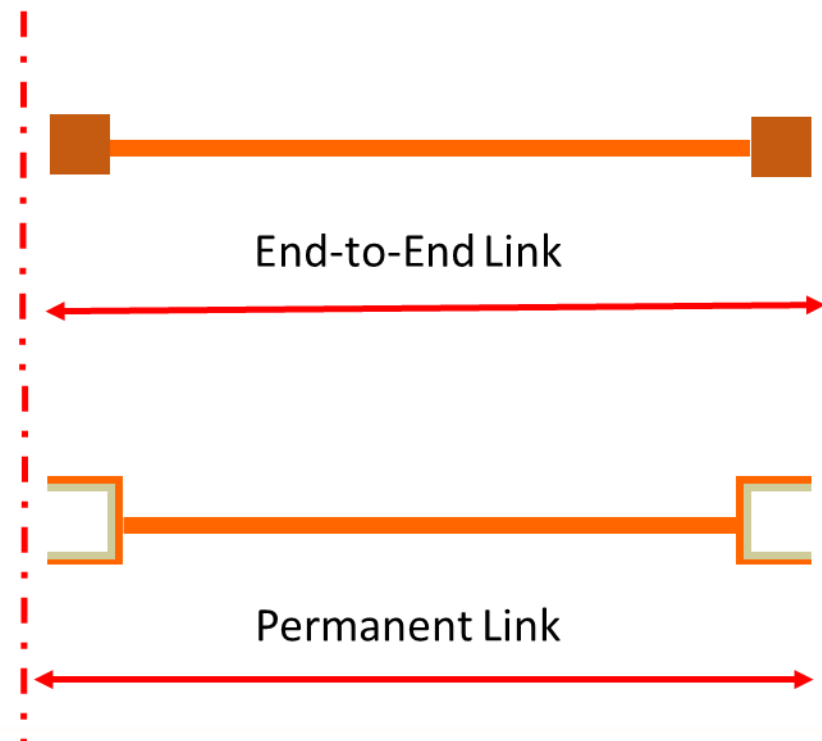

Socket

Plug

Measurement Cable  
Plug to Plug



Measurement Cable  
Plug to Socket





# Testing Requirements for E2E Cabling

- Implications for field testers
- Classical Channel test setup CANNOT be used  
Channel tests do NOT include the first and last connector

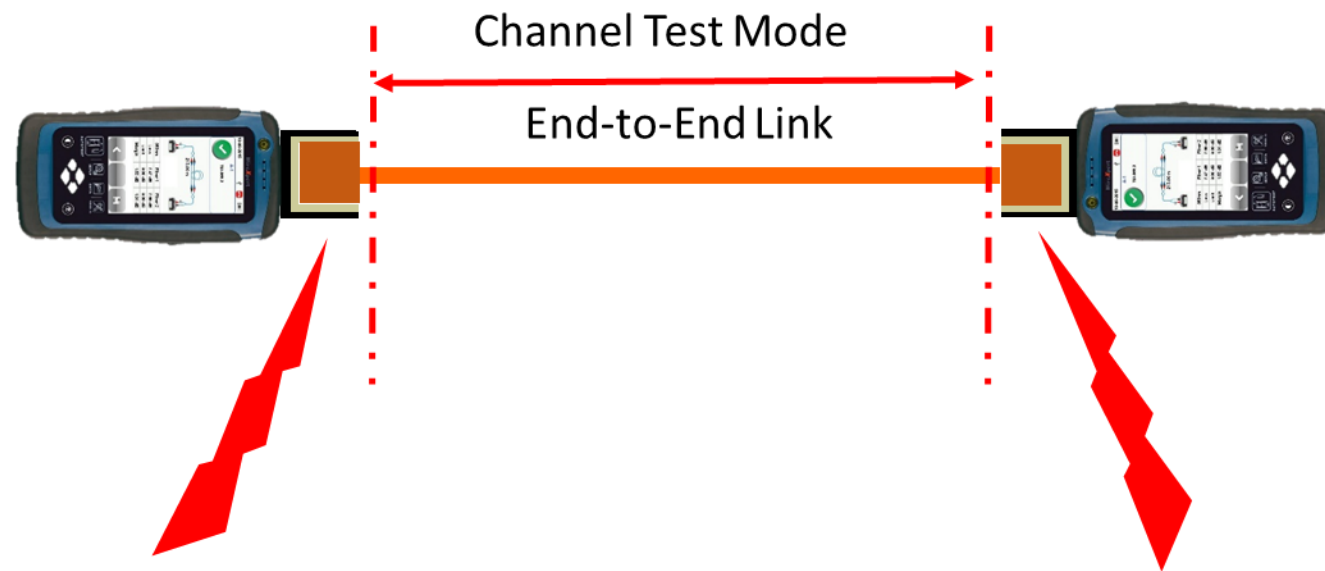

Socket

Plug

Measurement Cable  
Plug to Plug



Measurement Cable  
Plug to Socket



- **Failures due to field termination other than simple wiremap errors can not be found using Channel mode!**





# Testing Requirements for E2E Cabling

2 Approaches to include first & last connector

- A: Use channel adaptors und special software

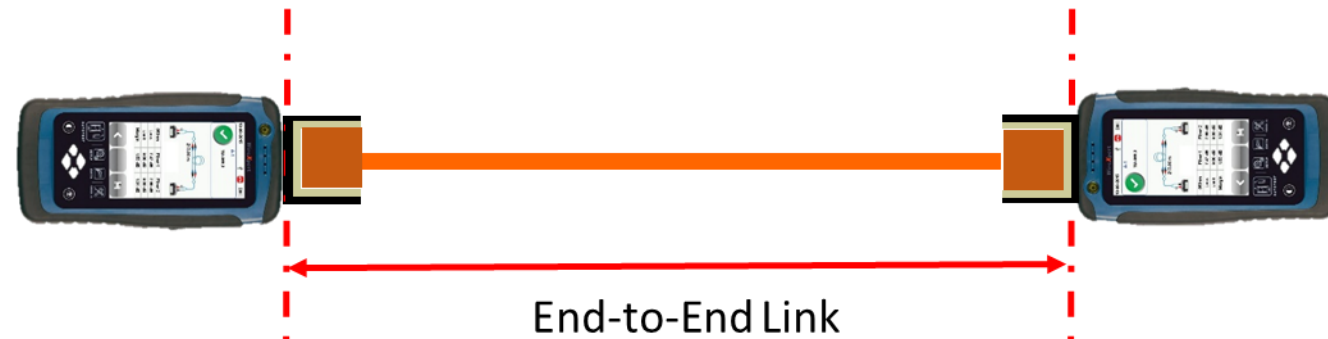

- B: Use channel adaptors and hybrid cords

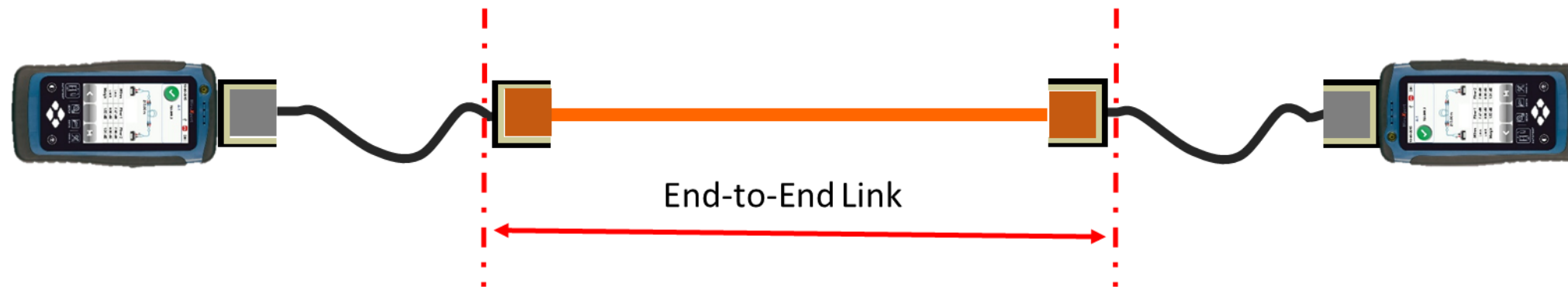

Socket

Plug

Measurement Cable  
Plug to Plug

Measurement Cable  
Plug to Socket

- Advantage of B

- **more flexible – easier to reach tight or exposed locations**
- **Easier to implement new connectors**



# Normative References

- IEC14763-4: Measurement methods to test E2E links
- ISO11801-9902: Testing of E2E links
- ANSI/TIA 1005: Infrastructure for Industrial Premises

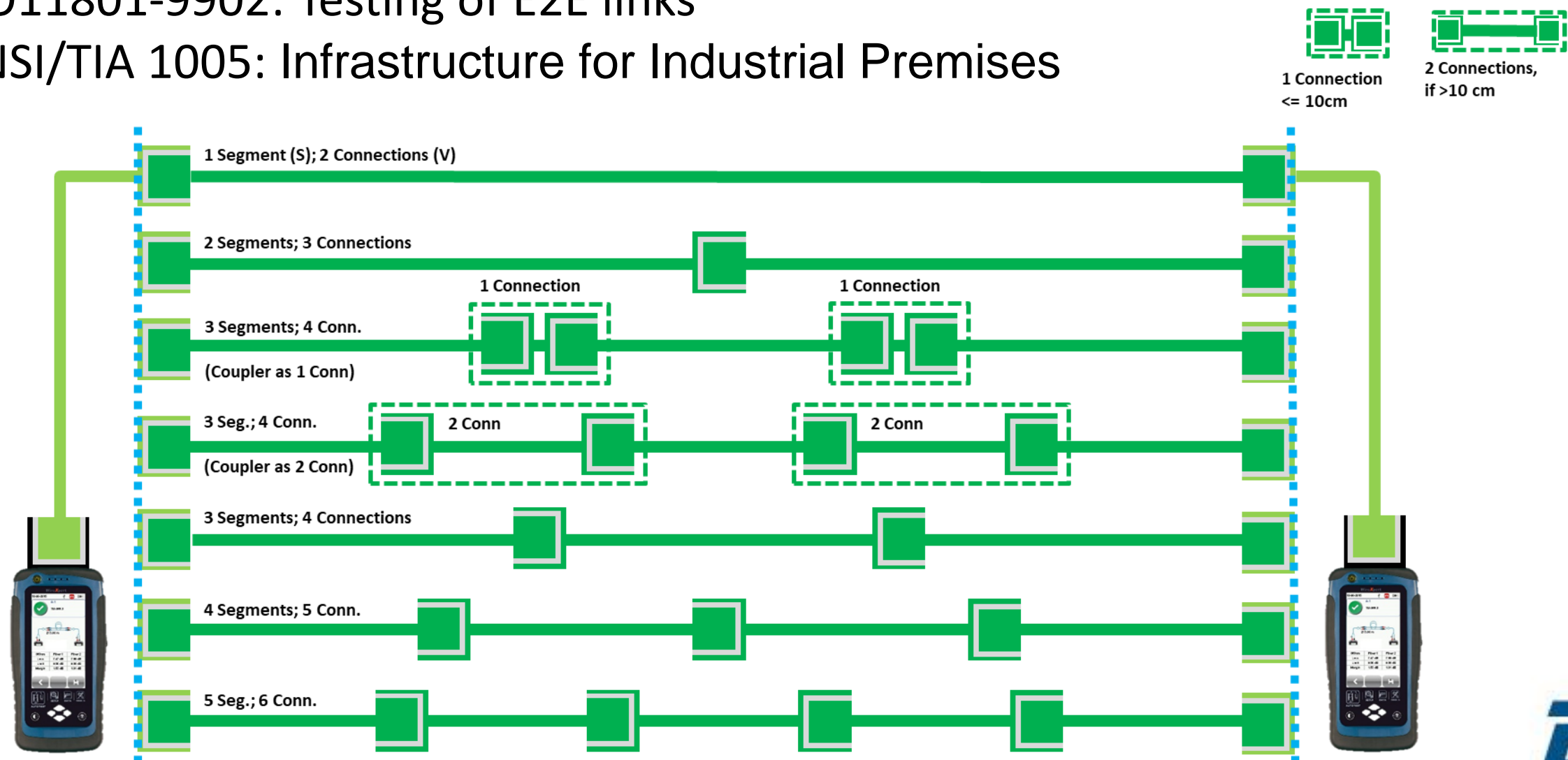



# Normative References

- To best possible reflect the requirements for IoT devices, those standards contain various E2E link configurations: 1 up to 5 segments
- Note that 2 connectors close to each other may be seen as 1 or 2 connection  
„1 connection“ if the distance between 2 connectors is less than 10cm -> bulkhead  
„2 connections“ if distance is more than 10cm

- A segment may also contain a „socket to plug“ assembly
- At current, standards only define E2E up to CAT6 / Class E

- **Another important difference to channel testing:**

**All different configuration have different testing limits**

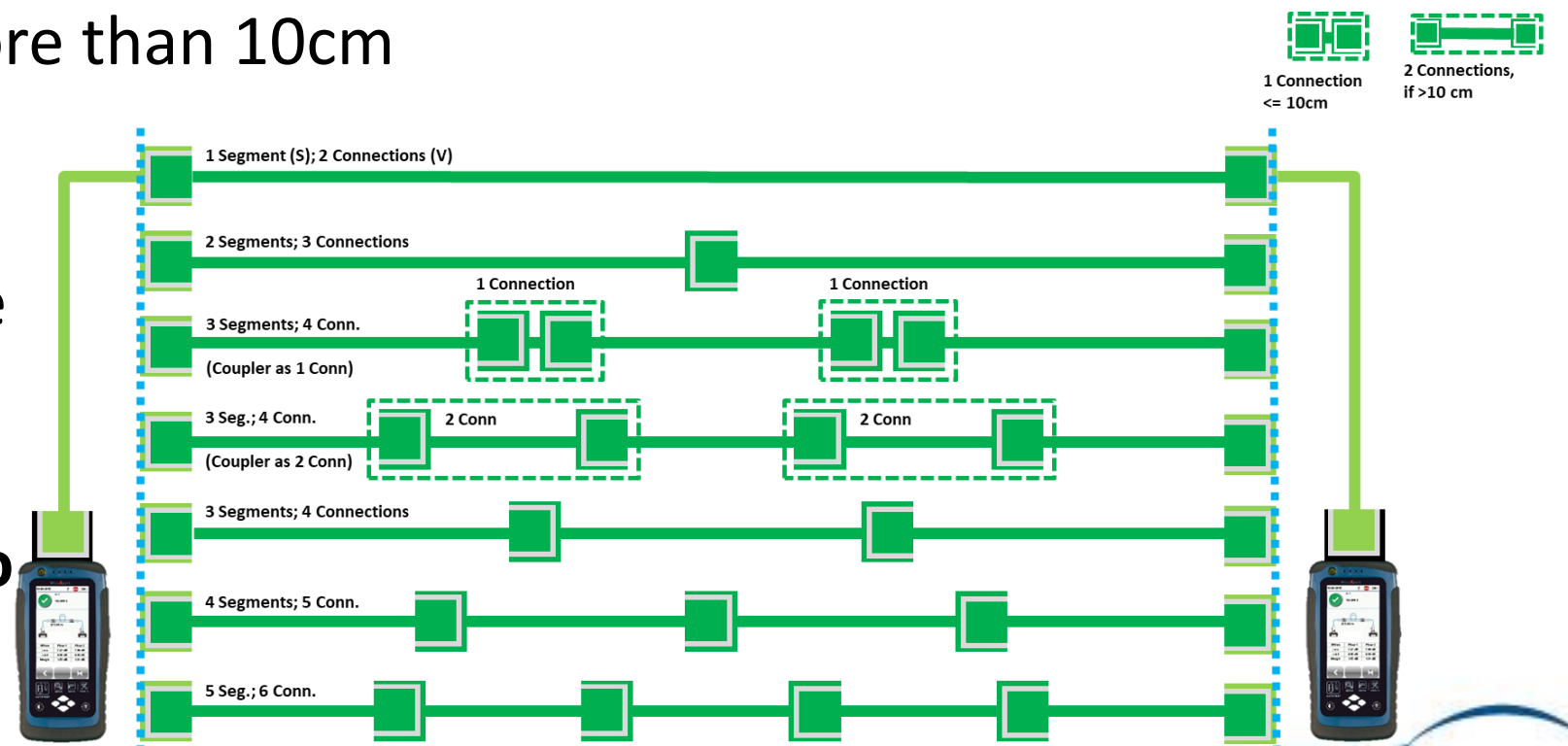



# Normative References

Important differences to patch cords

- An E2E link is NOT a patch cord
  - A patchcord is one part, an E2E link can consist of up to 5 segments
  - Different length, potentially different cable types (solid, different diameters)
  - Different testing requirements
- An E2E Link always has to be tested as a complete link  
Adding up segments requires re-testing of the complete link

## Example

Sum of 3 individual segments



≠

≠

3 segments joint with bulkheads







## Practical Guidelines

- Make sure your tester supports E2E links
- At current, standards only define measurement up to CAT6 / Class E  
=> max Ethernet supported speed is 1000MBit/s  
If 10GBit/s performance is required, Softing at current recommends to use hybrid cables and CAT6A / Class E<sub>A</sub> permanent link limits
- Hybrid cords can help to access tight or exposed locations  
- > BUT make sure the device is able to handle measurement using hybrid cords

End to End
ISO - Five Connection Class D E2E Link
ISO - Five Connection Class E E2E Link
ISO - Four Connection Class D E2E Link
ISO - Four Connection Class E E2E Link
ISO - Three Connection Class D E2E Link
ISO - Three Connection Class E E2E Link
ISO - Two Connection Class D E2E Link
ISO - Two Connection Class E E2E Link





# Practical Guidelines

How to figure out an unknown link configuration??

- Use a device with time-domain features for NEXT or Return Loss also known as
  - TD-NEXT or NEXT Locator                      TD-RL or RL Locator
- Run an Autotest with above features enabled
- Look at NEXT or RL Locator results. The peaks will tell you how many connections are present in that link
- If the E2E link consists of more than one segment, you will need to double check if each peak is one connection or two (10cm is shorter than the typical length resolution of time domain features)

Example:  
2 Segment E2E link

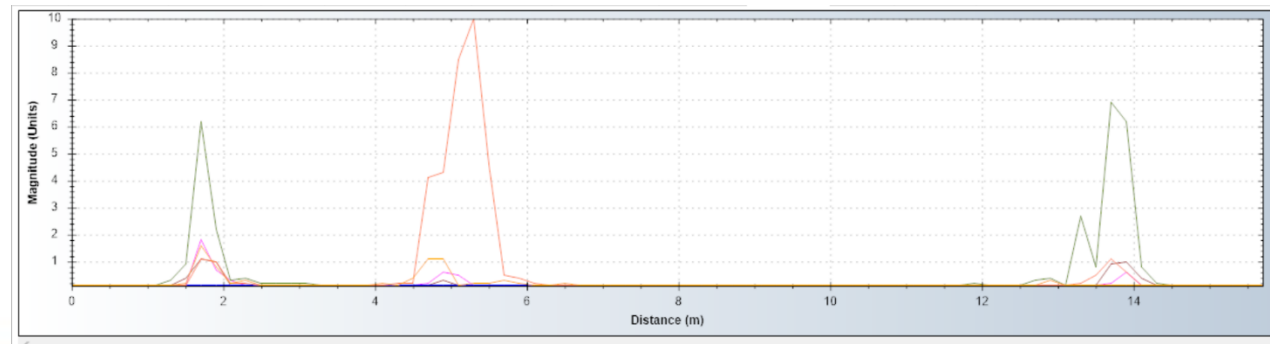



## Outlook – Other Examples for E2E Applications

- **Data Center**

Direct connection between devices

Example servers in the same row

(Note: E2E not yet standardized for CAT6A / Classe E<sub>A</sub>)

- **Professional Entertainment**

Cabling “on the fly” for stages equipment

- **Home Networking/Entertainment**

Homes go more and more wireless, but every access points needs a data cable...



# Outlook – what Comes Next?

## E2E and 10GBit/s

- Next revision of ISO standards will contain limits up to CAT6A / Class E<sub>A</sub>

## 1 Pair – Various new configurations – new field of applications

- 15m and 40m
  - Mainly interesting for automotive applications
    - 15m for cars, 40m for busses and trucks, **minimum** 1GBit/s
    - Car sensors, cameras, actors, controls, entertainment
- 1000m, 10MBit/s
  - Very interesting for industrial automation, IoT devices
  - Drive any sensors, building automation devices, cameras
- PoDL: **P**ower **o**ver **D**ata **L**ines
  - 1 Pair cabling to provide power to IoT devices





# Outlook – what Comes Next?

## Newest Ideas for 1 pair

- Adopt 1 pair cabling also for office applications
  - 100m, 1000MBit/s
  - New “consolidation point”-like structure  
4 pair to a “consolidation point” and  
then 4 x 1 pair to 4 devices
- Reasons
  - Many office devices do not need more than 1000MBit/s
  - Laptops become so small that they cannot accept a RJ45 anymore
  - Provide a copper Ethernet link to tablets, monitors, terminals using a smallest possible cable and connector

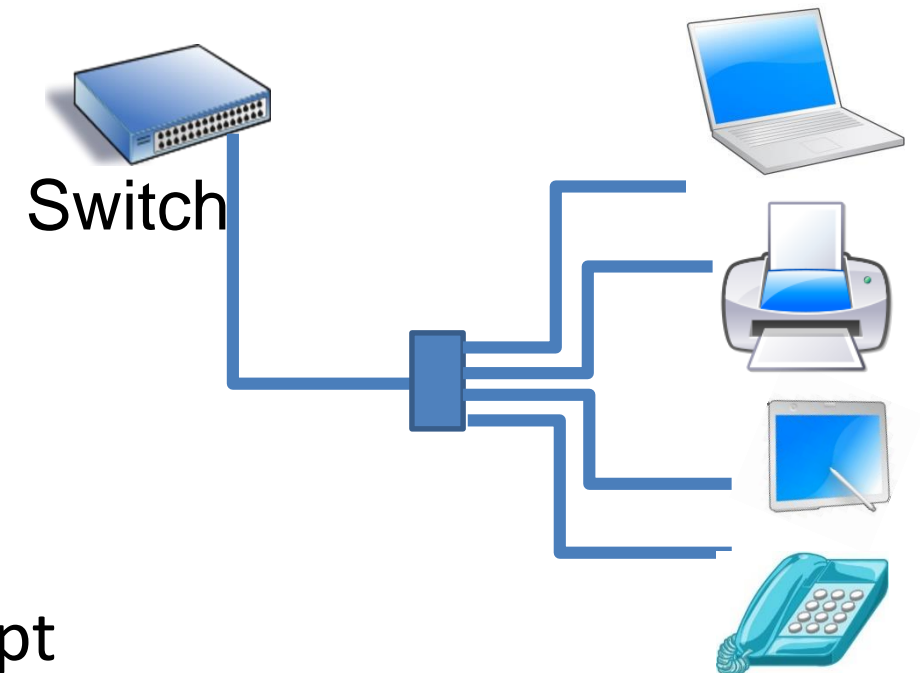



## Summary

- IoT opens up a wide area of cabling and testing applications
- Increasing speeds and performance requirements make testing absolutely necessary
- Testing of IoT cabling requires special testing approaches and MUCH more flexibility in terms of what needs to be tested
  - Various different connector types
  - Various different configurations
- First round of IEEE , ISO/IEC and TIA standards are released
  - Further standards will follow to cover new applications



**Questions?**

**Thank you for your attention**

**[Eric.Lie@softing.com](mailto:Eric.Lie@softing.com)**

**<http://Itnetworks.softing.com/asia>**